

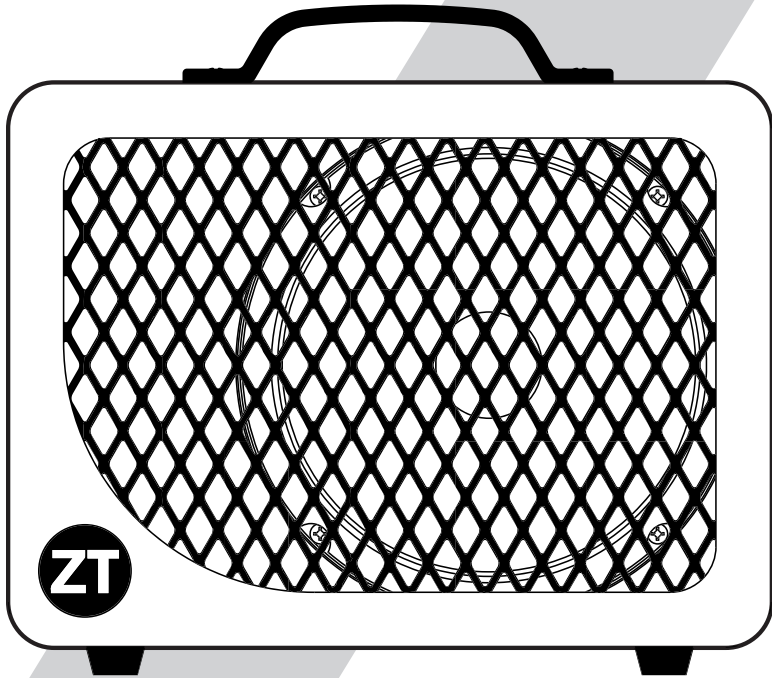

AMPLIFIERS
BELIEVE WHAT YOU HEAR



LUNCHBOX REVERB

GUITAR AMPLIFIER - LBR1

A Message from ZT

Thank you for purchasing a ZT Lunchbox Reverb. Our mission to make lightweight, compact, high-quality amps that ease the lives of musicians everywhere began when we released our flagship ZT Lunchbox in 2009. It soon found prominent places in the arsenals of some of the world's most accomplished players.

We've spent the years since scheming, tinkering, and refining the original Lunchbox's combination of power, performance, and portability to make the amp you are holding today. Rest assured: no detail was too small, and no possibility was left unconsidered.

The Lunchbox Reverb is the next phase of our evolution. These are first-class amps, designed by musicians, for musicians – a seamless blend of creativity and engineering, proudly assembled in our Benicia, California headquarters. We hope you enjoy playing your amp as much as we enjoyed building it.

Questions and Service

We believe in customer service at ZT Amplifiers. Whether your amp is old or new, working or damaged, used on the stage or in the studio – we're here to help however we can. Our support staff – the same people who designed and built your amp – are here to answer technical questions, diagnose problems, and offer advice. Contact them at **techsupport@ztamplifiers.com**.

If you are having an issue with your amp, please include your product's serial number and provide as much detail about the problem as possible. The more we know, the faster we can assist you. If we determine that your product is in need of service, we will coordinate with you to get your amp repaired as quickly as possible.

Technical Specifications

Input Impedance: $>1M\Omega$

Speaker Driver: 6.5 inch (165mm)

Dimensions: 9" (225mm) h x 10" (250mm) w x 5.5" (140mm) d

Weight: 10 lb (4.6 kg)

SPL: $>123\text{dB}$ at 1 meter

Output Power: 100 watts RMS

Voltage: 115V / 230V Selectable

Top Panel Controls: Gain, Bass, Mid, Treble, Volume, Reverb

Rear Panel Controls: Speaker On/Off, Power, 115V/230V Voltage Selector

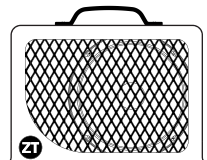
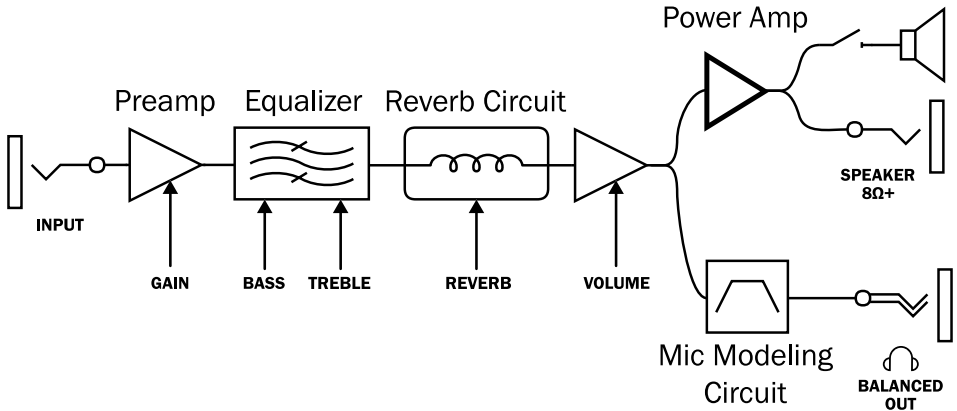

Block Diagram



Top Panel Features

1. INPUT Jack – Plug in your instrument here. The input can take a wide range of instrument signal levels based on how you set the GAIN control.
2. GAIN Control – Adjusts the amount of input signal to the preamp. GAIN should be adjusted depending on the output of your instrument and can be used for overdrive by setting it near maximum. We generally recommend keeping gain above halfway and using VOLUME to adjust your output level.
3. BASS Control – Adjusts the low frequency level.
4. TREBLE Control – Adjusts the high frequency level.
5. VOLUME Control – Adjusts the master volume of the amplifier.
6. REVERB Control – Adjusts the amount of spring reverb added to your signal.
7. Pilot Light – LED that indicates the amplifier is on.

Rear Panel Features

8. Headphone / BALANCED OUT Jack – 1/4 inch (6.35mm) TRS output that can be used to power headphones or send a line out to a PA or recording equipment. This output is compensated to be identical to a microphone in front of the speaker. Note: This is a balanced signal, not traditional stereo. It should be connected to the balanced input on professional equipment, it will not function in a stereo input.
9. Internal Speaker Switch – Turns on  or off  the internal speaker. Use this to mute the internal speaker when using the Lunchbox Reverb solely as a head to power an external cabinet or for silent practice with headphones. The Lunchbox Reverb will power the internal speaker and an external cabinet simultaneously.
10. SPEAKER Out Jack – Use a 1/4 inch (6.35mm) speaker cable to power an external speaker. Minimum recommended speaker impedance is 8Ω.
11. Power Switch – Turns the Lunchbox Reverb on or off.
12. Fuse – Protects the amplifier from electrical faults.
Fuse type: T2AL250V - 250V 2A Slow-Blow
13. AC Power Jack – Plug in your detachable AC power cable here.
14. Voltage Selector – Make sure that the voltage shown on the red switch is correct for your territory (115V for North America, 230V for Europe, etc.). Slide the switch to the opposite side to change the voltage setting. Setting the voltage incorrectly will cause permanent damage to the amplifier.

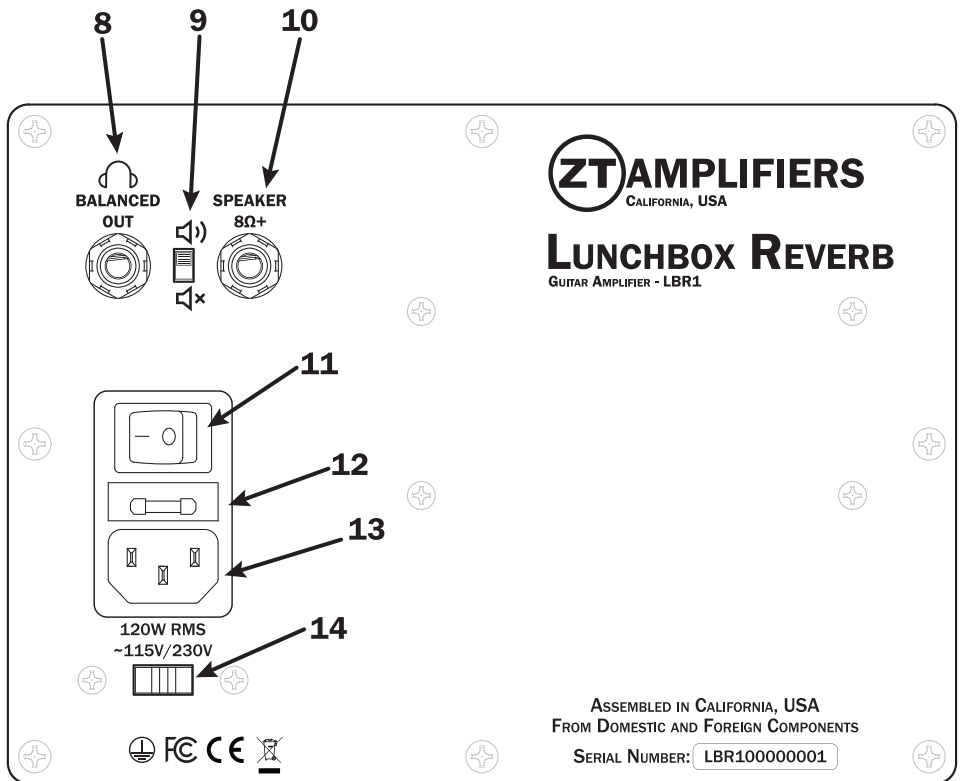
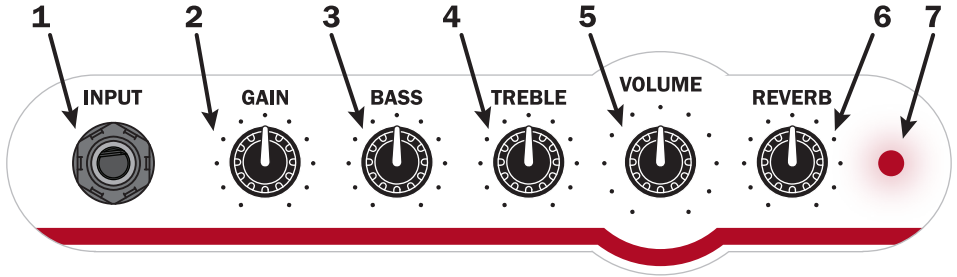

LUNCHBOX REVERB - LBR1



Important Safety Instructions

READ INSTRUCTIONS – All safety and operating instructions should be read before the appliance is operated.

RETAIN INSTRUCTIONS – Safety and operating instructions should be retained for future reference.

HEED WARNINGS – All warnings on the appliance and in operating instructions should be adhered to.

FOLLOW INSTRUCTIONS – All operating and use instructions should be followed.

WATER AND MOISTURE – The appliance should not be used near water or anywhere that it could come in contact with water.

CARTS AND STANDS – Do not place this product on an unstable cart, stand, tripod or table.

VENTILATION – The appliance should be situated so that its location and position do not interfere with proper ventilation. The appliance should not be situated on any surface that may obstruct airflow.

HEAT – The appliance should be situated away from any heat sources.

POWER SOURCES – This product should only be operated from the type of power source indicated on the marking label. If you are not sure of the power supply in your home, consult your product dealer or local power company.

POWER CORD PROTECTION – Power supply cords should be routed so that they are not likely to be walked upon or pinched by items placed upon or against them.

POLARIZED PLUG – This product may be equipped with a polarized plug (one blade wider than the other). This is a safety feature and should not be defeated. If you are unable to insert your plug into an outlet, contact an electrician to replace an obsolete outlet.

GROUNDING/EARTHING – This product must be connected to a mains outlet with a proper ground/earth connection.

LIGHTNING/POWER SURGES – For added protection for this product during a lightning storm or when it is left unattended and unused for long periods of time, unplug it from the wall outlet and disconnect any cables. This will prevent damage to the product during a lightning storm or power line surges.

OVERLOADING – Do not overload wall outlets, extension cords, or integral convenience receptacles, as this can result in a risk of fire or electric shock.

CLEANING – Unplug this product from the outlet before cleaning. Do not use liquid cleaners or aerosol cleaners. Use a damp cloth for cleaning.

NON-USE PERIODS – This amplifier should be unplugged from the outlet when the appliance is left unused for a long period of time.

OBJECT AND LIQUID ENTRY – Never push objects of any kind into this product through openings, as they may touch dangerous voltage points or short-out parts that could result in a fire or electric shock. Never spill liquid of any kind on this product.

DAMAGE REQUIRING SERVICE – This appliance should be serviced by authorized personnel when:

- The power supply cord or plug has been damaged; or
- Objects have fallen on, or liquid has been spilled into, the appliance; or
- The appliance has been exposed to rain; or
- The appliance does not appear to operate normally or exhibits a marked change in performance; or
- The appliance has been dropped or the enclosure is damaged.

SERVICING AND PARTS – Do not attempt to service this product yourself, as opening or removing covers may expose you to dangerous voltages or other hazards. Contact ZT Amplifiers to find warranty information or to locate authorized service personnel.

SAFETY CHECK – Upon completion of any service or repairs to this product, ensure the service technician has performed safety checks to determine that the product is in proper operating condition.

HEARING LOSS – Sustained high sound pressure levels can cause temporary or permanent hearing damage.

HEAT AND SUNLIGHT – Avoid lengthy exposure to high heat or direct sunlight to prevent damage to the finish.

ZT Amplifiers Limited Warranty

ZT Amplifiers warrants that its products purchased through an authorized dealer shall be free of defects in parts and workmanship if used under normal operating conditions for the following periods:

Amplifiers, Electronics, and Speaker Cabinets

- One (1) year from the date of purchase on speaker drivers and cosmetic issues
- Three (3) years from the date of purchase on all other issues

Accessories

- One (1) year from the date of purchase on all issues

This limited warranty shall run to the original purchaser when purchased from an authorized ZT dealer and any transferee of a retail purchaser. This limited warranty covers normal use of the ZT product only, and does not cover damages caused by misuse, abuse, accidents, or unauthorized service or parts.

Important: Please retain your sales receipt, as it is your proof of purchase covering your limited warranty. To transfer the warranty to a subsequent purchaser, you must endorse the sale of the product to the subsequent purchaser on the front of the sales receipt. This limited warranty is void without such endorsed sales receipt.

Defective products that qualify for coverage under this limited warranty will be repaired or replaced, at ZT Amplifiers' discretion, with a like or comparable product, without charge. Any repair or service performed by any person or entity other than an Authorized ZT Amplifiers Service Center is not covered by this limited warranty. This limited warranty becomes void if the serial number on any product is defaced or removed, or the product has been damaged by alteration, misuse, accident, or neglect; or the product has been repaired or serviced by persons not authorized by ZT Amplifiers.

THE FOREGOING CONSTITUTES THE ONLY WARRANTY MADE BY ZT AMPLIFIERS WITH RESPECT TO THE PRODUCTS AND IS MADE EXPRESSLY IN LIEU OF ALL OTHER WARRANTIES EXPRESSED OR IMPLIED. Any implied warranties, including, without limitation, any implied warranties of merchantability or fitness for any particular purpose, imposed under the law of any applicable jurisdiction are limited to the duration of this limited warranty.

ZT AMPLIFIERS ASSUMES NO LIABILITY FOR PROPERTY DAMAGE RESULTING FROM ANY DEFECT OF THIS PRODUCT NOR ANY LOSS OF BUSINESS, INCOME, PROFIT, SATISFACTION, OR DAMAGES ARISING FROM THE LOSS OF USE OF SAME DUE TO DEFECTS OR AVAILABILITY OF SAME DURING SERVICE. NOTWITHSTANDING ANY DAMAGES YOU MIGHT INCUR FOR ANY REASON WHATSOEVER, THE ENTIRE LIABILITY OF ZT AMPLIFIERS SHALL BE LIMITED TO THE AMOUNT ACTUALLY PAID BY YOU FOR THE DEFECTIVE PRODUCT.

Some jurisdictions do not allow the exclusion or limitation of damages or limitations on how long an implied warranty lasts, so the above limitations may not be applicable to you.

EFFECTIVE DATE: August 1, 2018

ZT AMPLIFIERS

LUNCHBOX REVERB - LBR1

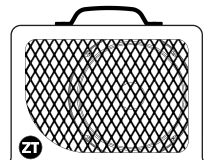

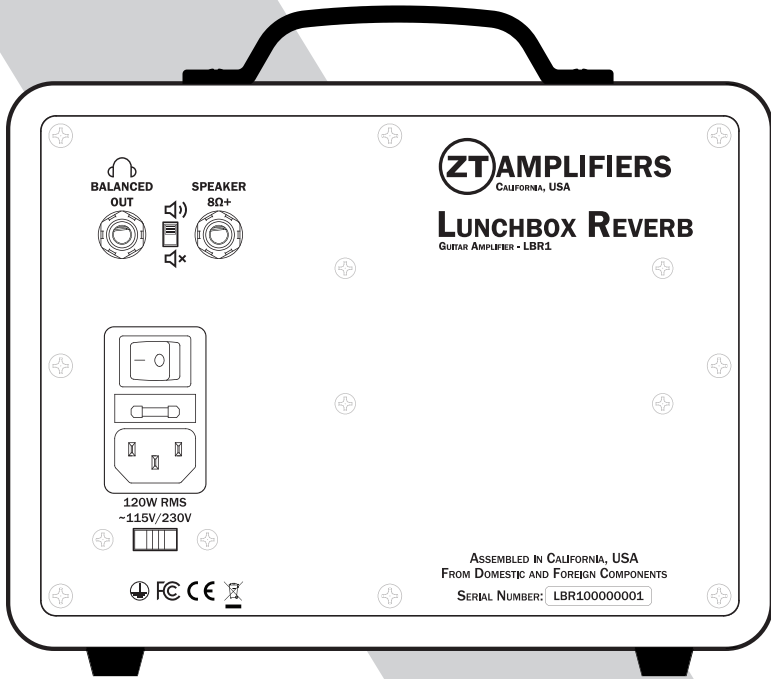

**ASSEMBLED IN CALIFORNIA
USA**